

REV.	DESCRIPTION	DATE

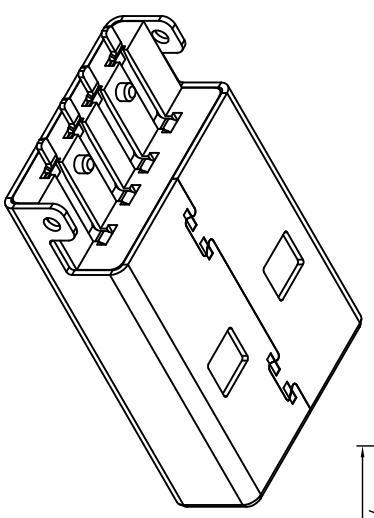
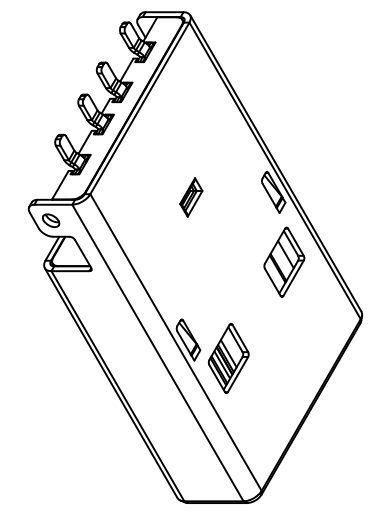
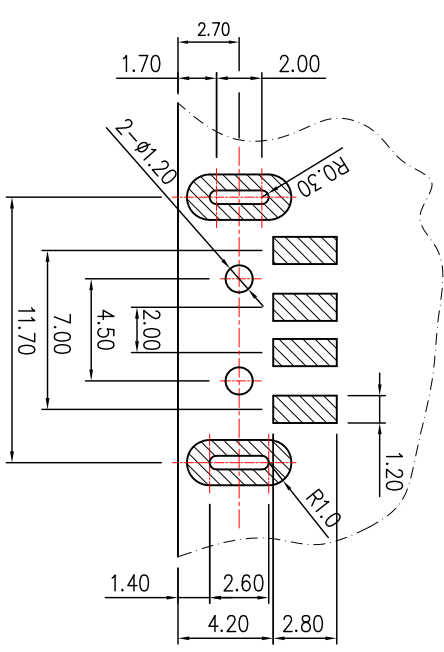
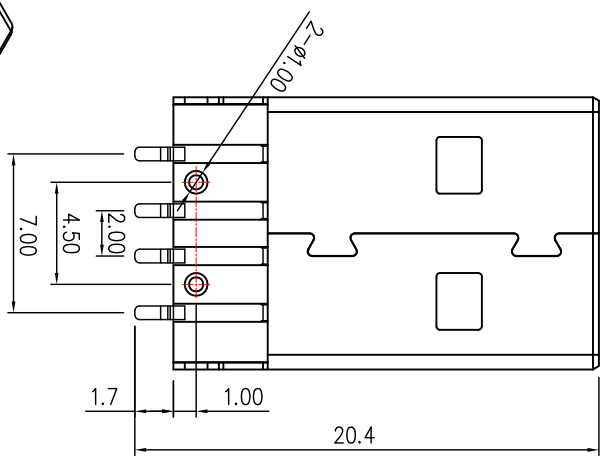
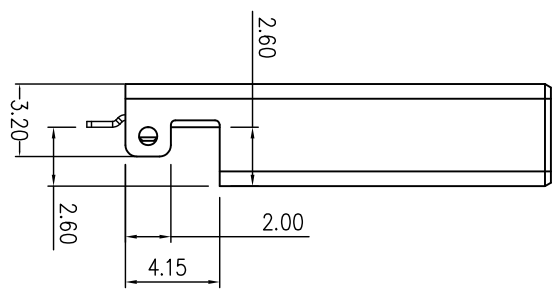
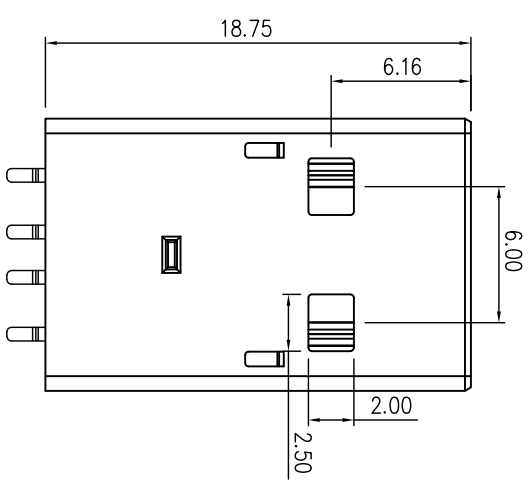
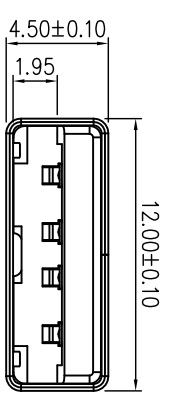

USB - A - PX - 260N - 120C

0 : None Post
1 : Ø1.0 Post

NOTE

- A. Insulator : High temp. plastic. UL 94V-0.
 - B. Contact : Brass T=0.25mm.
 - C. Plating : Selective gold plated on contact area ; min 50u" Nickel plated all over ; min100u" Sn on solder tail area.
 - D. Shell : Steel SPCC T=0.30mm
 - E. Shell Plating : min 60u" Nickel Plated.
- Electrical :
- A. Voltage: 30VAC(rms).
 - B. Current: 0.5A
 - C. Contact Resistance: 30mΩ (maximum)
 - D. Insulation resistance: 1000MΩ(minimum)
 - E. Dielectric withstanding voltage: 500V AC
 - F. Temperature: -55 °C to +80 °C
 - G. Durability: > 1500 cycles.

<p>TOLERANCE</p> <p>.X ±0.3</p> <p>.XX ±0.2</p> <p>.XXX ±0.1</p>		<p>DRAWER</p> <p><i>Chiu Chiu Siu</i></p>		<p>SynLight 日亮電子科技有限公司</p> <p><i>Sun-Light Electronic Technologies Inc.</i></p>	
<p>UNITS : mm</p>		<p>CHECK</p> <p><i>Mhi Jung Siu</i></p>		<p>NAME</p> <p>USB Connector A Type Plug SMT Series</p>	
<p>SCALE 3 : 1</p>		<p>DESIGNED</p> <p><i>Chiu Chiu Siu</i></p>		<p>PART NO.</p> <p>USB-A-PX-260N-120C</p>	
<p>SIZE A4</p>		<p>APPROVAL</p> <p><i>Steve Tseng Siu</i></p>		<p>DATE</p> <p>1 / 20 / 2015</p>	
<p>SHEET 1 OF 1</p>		<p>DATE</p> <p>1 / 20 / 2015</p>		<p>REV.</p> <p> </p>	